

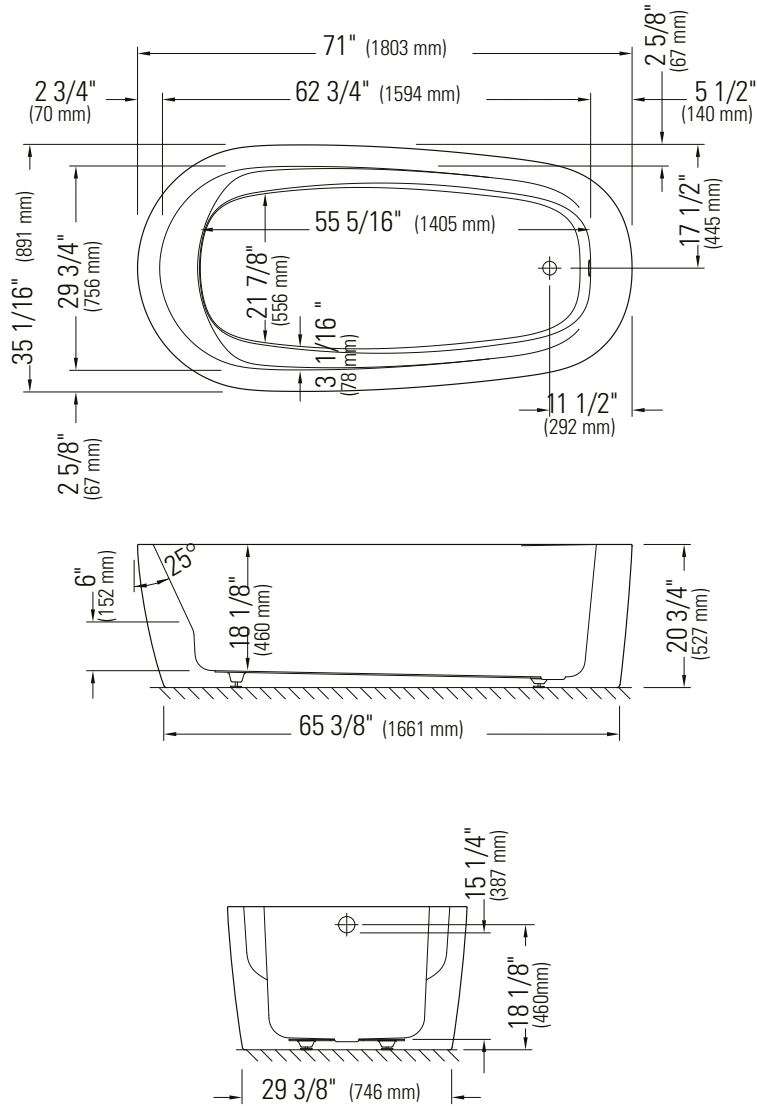

Produits Neptune

## VAPORA F1 3672



\*A bathtub fitted with back jets can cause the pump to protrude by approximately 3" from the overall dimension.

\*\*All dimensions are approximate and subject to change without notice. Please refer to the installation guide before beginning the installation

6835 PICARD STREET  
SAINT-HYACINTHE, QUEBEC J2S 1H3  
CANADA

PHONE 450 773 7058  
FAX 450 773 5063  
TOLL-FREE CANADA 1 888 226 7099  
TOLL-FREE USA 1 888 226 7899

produitsneptune.com

06-2015